

8, 4, 2 Channel Audio Delay

C8685

features

- 8Ch / 4Ch / 2Ch variable audio delay
- 1,36sec. / 2,72sec. / 5,44sec. maximum delay times
- Setup of delay times in ms (coarse) and samples (offset)
- Automatic display of delay times in frames and ms
- bit transparent for Non Audio (e.g. Dolby E) signals
- Remote control via C8702 Frame Controller, GPI/O or http based API

block diagram

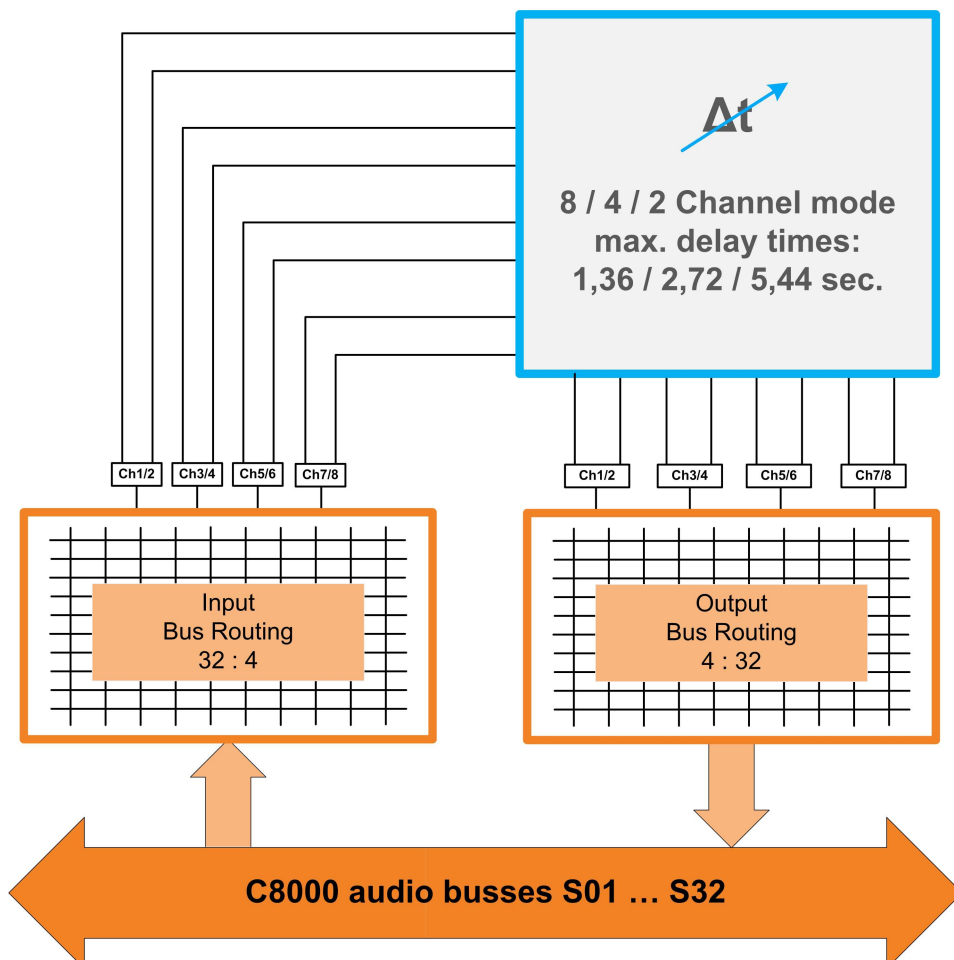

technical specifications

AUDIO :

resolution :	24bit
sample rate :	32...48kHz
audio processing :	8 / 4 / 2 channel audio delay
	Delay times:
8Ch	0ms ... 1,36sec.
4Ch	0ms ... 2,73sec.
2Ch	0ms ... 5,46sec.

GENERAL :

backplane connector :	ref. to DIN41612, 64pin, a+b, male
power supply :	+5V DC
power consumption :	approx. 150mA
dimension :	3RU, 4HP, 160mm depth
temperature :	10°C ... 40°C
humidity :	90%, non condensing

location of switches:

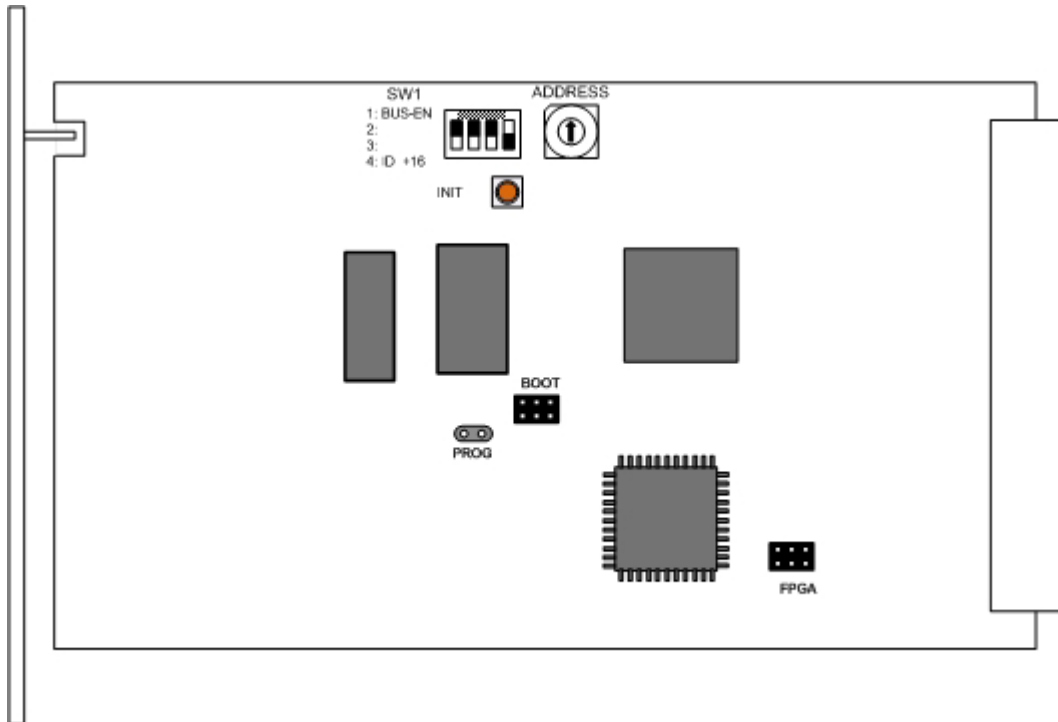

initial set up / bus assignment

For the initial setup the **CAN ADDRESS** selection is the most important setting. To avoid address conflicts with other C8k modules the CAN address setting must be done with care, because each CAN address has to be unique! See C8k System manual for details.

The Dip-Switch **#4** serves as **+16** address range extension for the CAN address switch.

The Dip-Switch **#1** is the **BUS-EN** switch which turns the audio driver circuits on when power is turned on. This allows you to insert a new module into an existing system without the risk of disturbing signals on other busses, if the actual bus configuration is unknown.

The **INIT** button will initialize the module to factory default if one holds it down while power up.

switch settings

BUS-EN:	ON Connects the outputs to the C8k audio buses on power up OFF Disconnects the module outputs from the C8k buses on power up
SW1 #2	not used
SW1 #3	not used
ID +16:	ON CAN address is extended by +16 (counting from 0x10 to 0x1F) OFF CAN address is standard (counting from 0x0 to 0xF)

Important note! To avoid audio bus conflicts when you replace a **C8685** or install an additional one and the configuration is unknown, the output bus drivers must be disabled before inserting it. If all settings are done remotely and the unit fits into the bus assignment scheme of a frame, you must remove it and place the switch back into position **BUS-EN=ON**.

rotary encoder settings

ADDRESS: This **rotary encoder** sets the **CAN ID** of the **C8685**. The 16 switch positions are hexadecimal numbers (0x0 to 0xF).

remote control operation

- Web-server based remote control of parameters via frame controller C8702
- 3rd party remote control by http protocol based API (please contact Junger Audio for details)
- Hardware GPI/O control of preset operation and special module functions
- Remote control by the **brc8x Broadcast Remote Controller** via CAN bus

web browser based GUI

**Set up of all configurations, parameters and functions via a web browser.
See also C8702 Frame Controller manual and respective firmware release notes.
Layout and functionality are related to firmware version 1.8.x of the C8702.**

OVERVIEW

The modules overview of a frame (below the display of an example frame) :

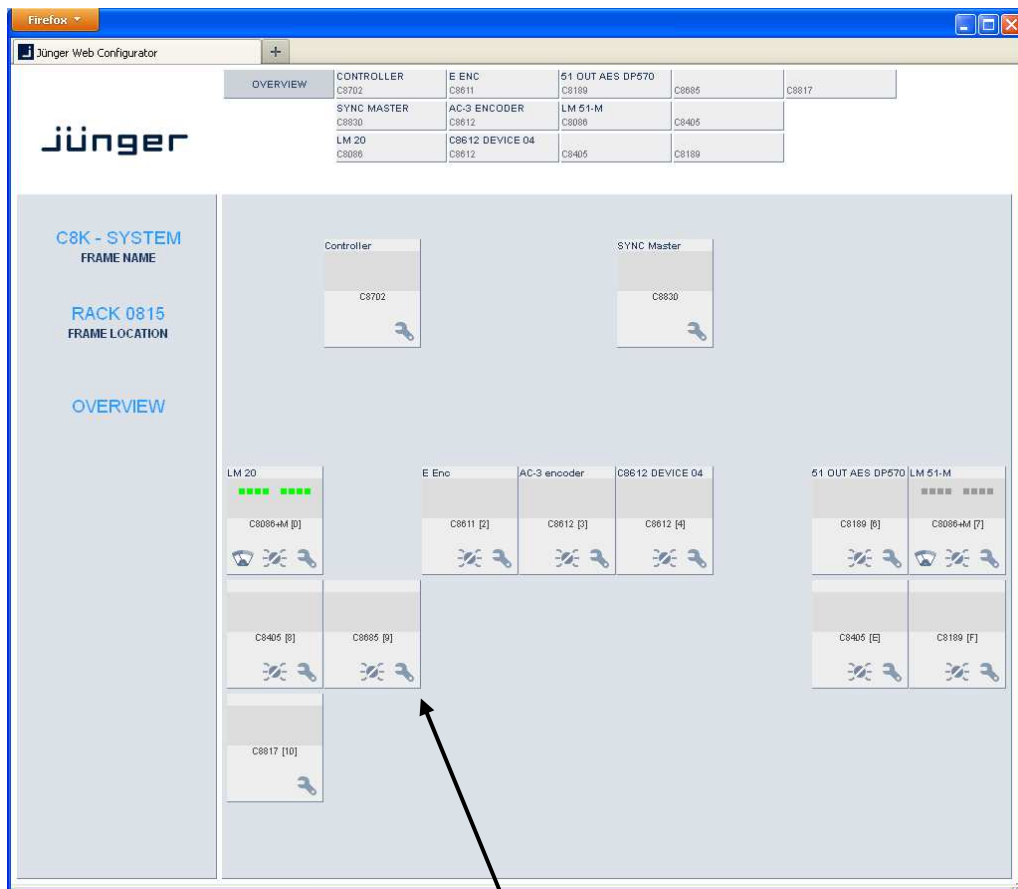

By simply clicking on the spanner tool symbol you will get the control pages of the **C8685** and the status window on the left side, which you will also see on mouse over. The entrance to the module setup is the **PRESET** page:

PRESETS

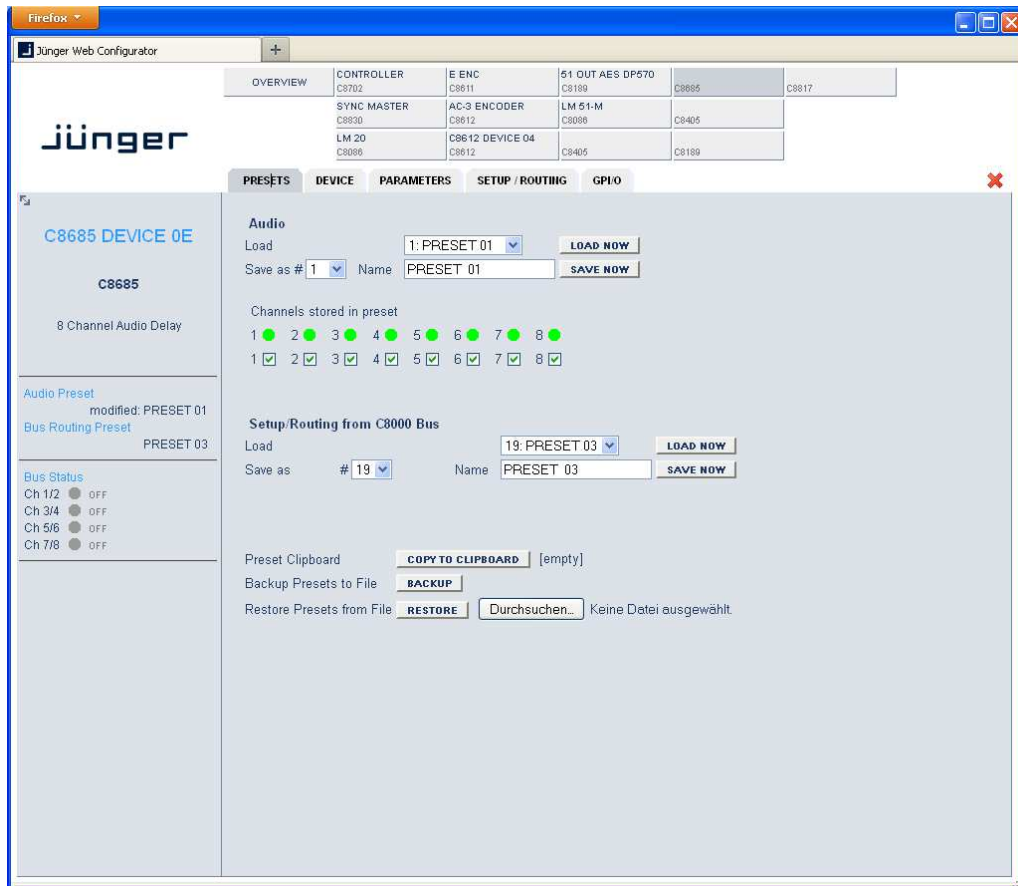

The **C8685** has 16 **Audio** (Delay) presets (# 1 ... 16) and 8 **Setup/Routing** presets (# 17 ... 24). The status window at the left hand side shows the names of the active presets. The phrase “**modified:**” will appear in line with the preset name, if a preset parameter was changed by the operator.

Audio

- Load** select a preset by name and press **<LOAD NOW>**.
- Save as #** select a preset memory number.
- Name** assign the preset a name (up to 16 digits) and press **<SAVE NOW>**.
- Channels stored in preset** you must tick the respective checkbox prior to save a preset in order to make that channel part of the preset. The soft LED lights green if that channel is part of the active preset.

Setup/Routing from C8000 Bus

- Load Preset** select a preset by name and press **<LOAD NOW>**.
- Save as Preset #** select a preset memory number.
- Name** assign the preset a name (up to 16 digits) and press **<SAVE NOW>**.

8, 4, 2 Channel Audio Delay

C8685

Preset Clipboard

copies the active preset to a clip board, The data may be used by other modules inside the **same** frame.

Backup Presets to File

creates an backup **XML file** which may be stored to the PC

Restore Presets from File

you can select a backup file from the PC.

DEVICE

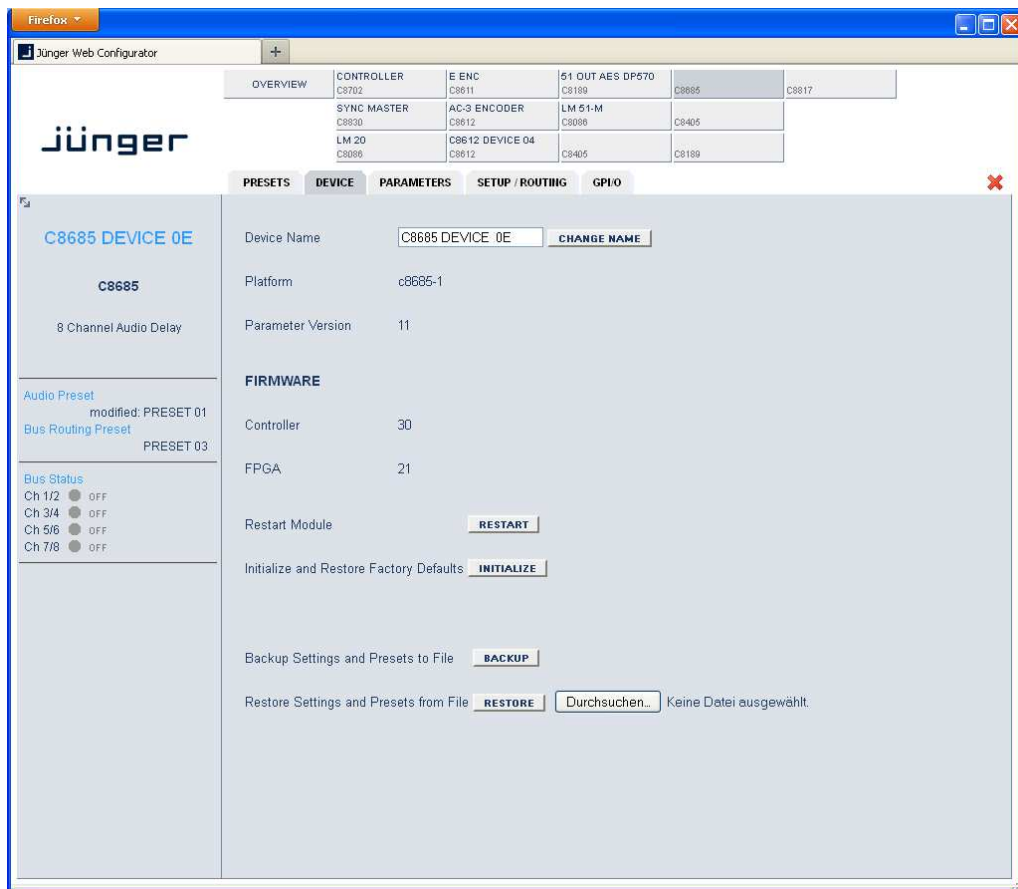

Device Name

you can assign the module a name (up to 16 digits) and assign it by pressing **<CHANGE NAME>**.

Platform

shows the hardware platform of the C8685

Parameter Version

shows the parameter version of the module controller

FIRMWARE

Controller

shows the firmware of the module controller

FPGA

shows the actual firmware of the Module FPGA

Restart Module

<RESTART> performs a warm start (soft reset)

8, 4, 2 Channel Audio Delay

C8685

**Initialize and Restore
Factory Defaults**

<INITIALIZE> restores the factory default values for all parameters of the module including all presets. The input bus assignment will be set to S01 ... S04, The outputs are turned OFF and the bus drivers will be disabled.

**Backup Settings and
Presets to File**

<BACKUP> will put all active parameters and the content of all presets into an XML file. You may store such file on a PC.

**Restore Settings
and parameters from File**

you may select a matching XML file from a PC.

<RESTORE> will overwrite all active parameters and the content of the presets by the content of the backup file.

PARAMETERS

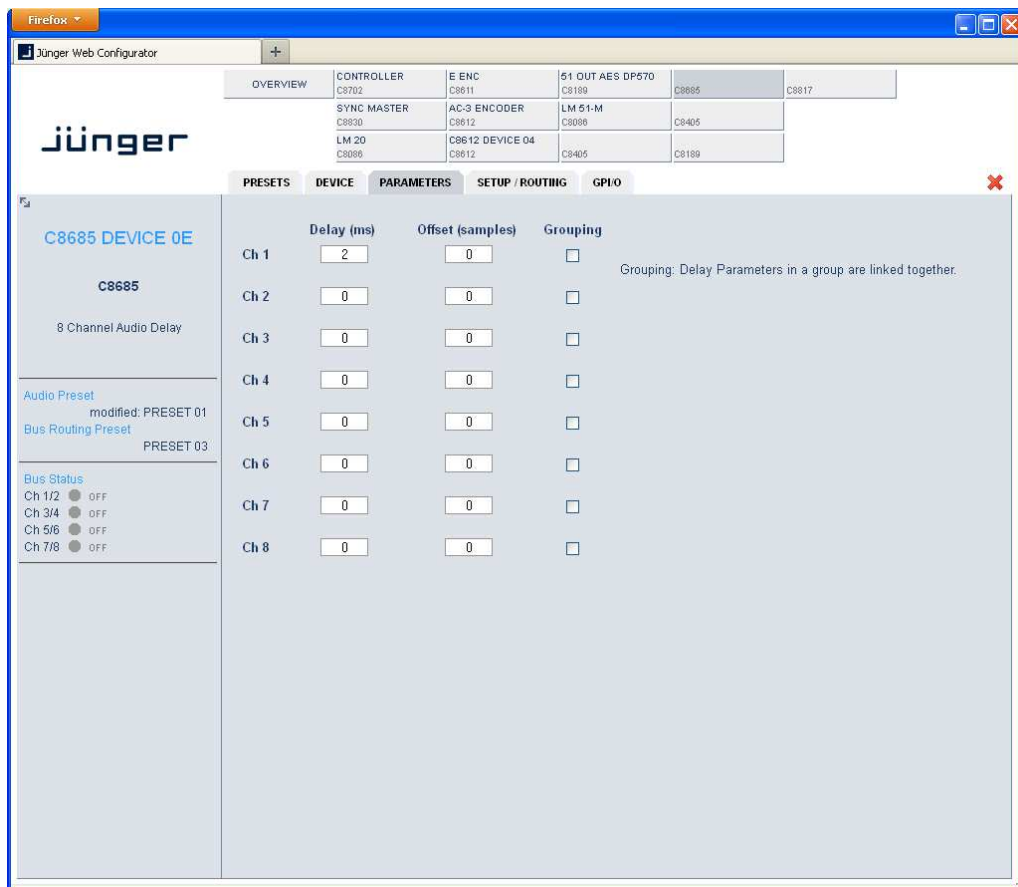

The display here depends on the Channel Mode selected on the SETUP / ROUTING pane. This example shows the delay configured for 8 independent channels.

Delay (ms)

[0 ... 1359ms] 8ch mode / [0 ... 2724ms] 4ch mode /
[0 ... 5455ms] 2ch mode
coarse setting of the delay time.

8, 4, 2 Channel Audio Delay

C8685

Offset (samples)

[0 ... 255]
fine tuning of the delay time.
E.g. one sample equates to ~0,21ms @ 48kHz SR.

Grouping

if you check the **Grouping** check box, the parameters of all grouped channels will be set together.

SETUP / ROUTING

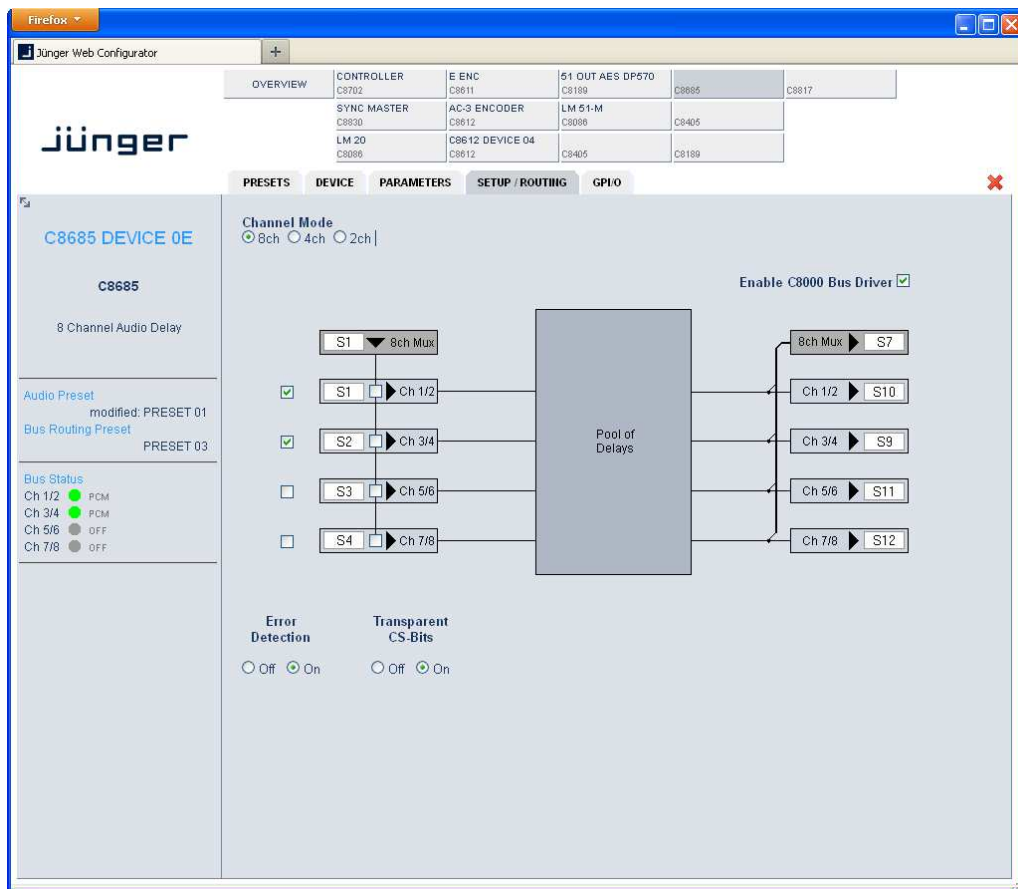

Channel Mode

[8ch, 4ch, 2ch]
configures the delay to operate as an **8x1Ch** or **4x2Ch** or **1x2Ch** device. The maximum delay time per channel depends on the selected channel mode.

Error Detection

[Off, On]
The serial audio data from the frame bus can be monitored for proper positioning of an **Error-Flag**. A bad position or non **Error-Flag** is an indication that there is disturbance upstream (input signal, input module, other DSP module).
The **Error Detection** can be turned **Off** and **On** in general and individually for each input from the bus. You will see the status of the busses on the left hand side : **"Bus Status"**.
A **grey** soft LED shows that the detection is disabled. While **green** is OK, **red** indicates an error condition.

8, 4, 2 Channel Audio Delay

C8685

The bus status may be presented to external monitoring systems via **SNMP**. The frame controller summarizes such status information and generates **SNMP traps** for the frame as an entity or may activate GPOs (if GPI/O module(s) are installed). The **SNMP manager** may afterwards poll the “**modulesStatus**” for more detailed status information per input (see SNMP documentation for details).

Input Bus selection

here you assign the audio signals from the c8k busses to the delay inputs. You may select one bus that carries all 8 channels by the so called **8ch Mux** mode (8 channels multiplexed on one bus line) or you may select the audio signals for a specific pair of delay inputs from a two channel bus or you can mix this selection by extracting channel pairs from the 8ch Mux bus and from two channel bus.

Output bus assignment

you may assign all 8 channels of the delay output to one bus that carries them by the so called **8ch Mux** mode and / or you may assign pairs of delay outputs in 2ch mode to dedicated busses.

Enable C8000 Bus Drivers

activates (from tri state mode) all module bus drivers.

Transparent CS-Bits

defines if the AES channel status bit will be put through from the input or if it will be exchanged by the following settings:

Format :	Professional
Audio Mode :	Audio
Emphasis :	None
Freq. Mode :	Locked
Sample Freq. :	48kHz
Channel Mode :	Not Indicated
User Bits :	None
Auxiliary Bits :	24Bit
Audio Word Length :	Not indicated

GPI/O

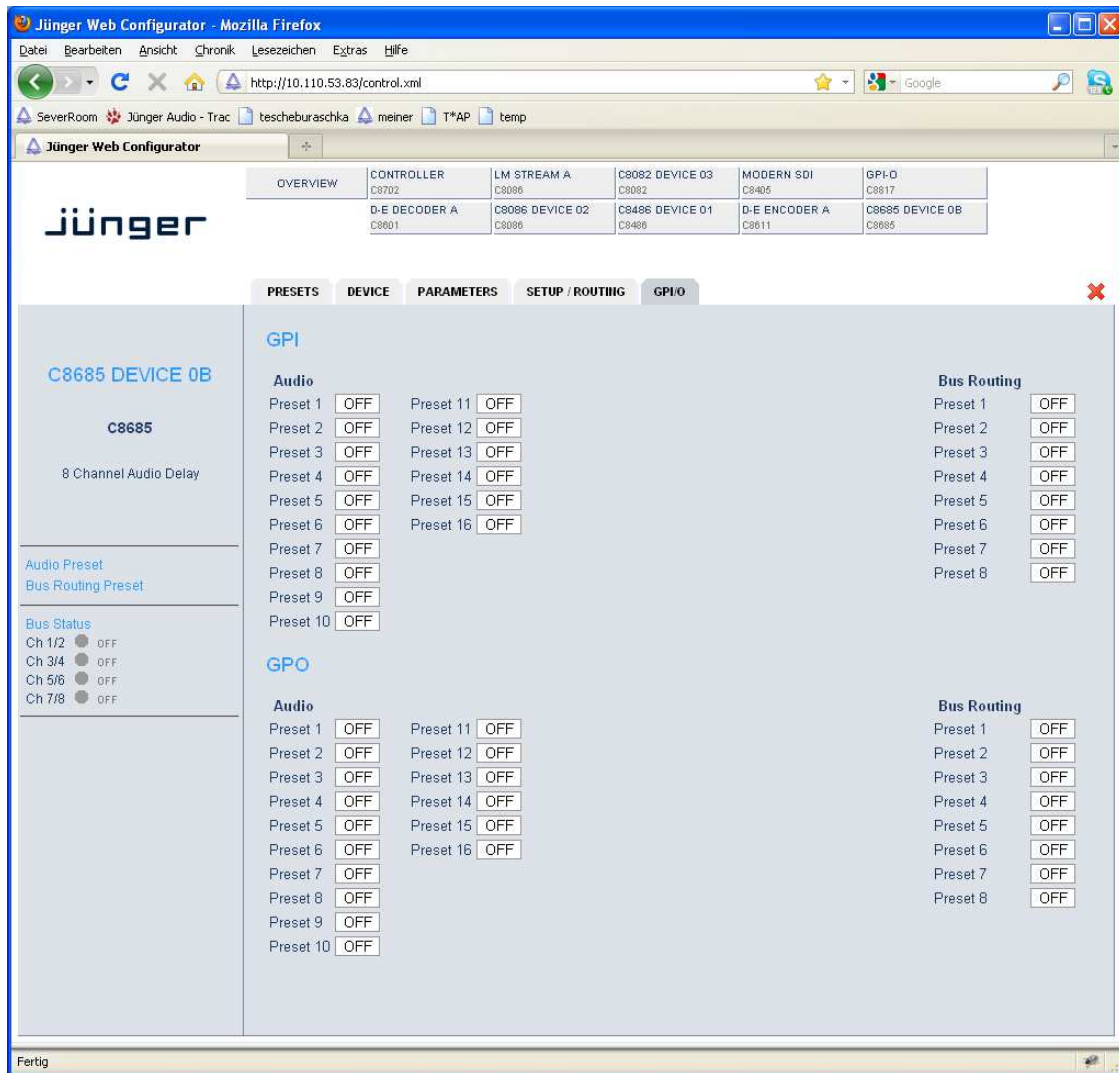

GPIs

are useful if you want to recall settings remotely (e.g. by presets). The C8k frame can handle **127** different **GPIs**. You must assign a unique number to the respective function. Such numbers will be generated by the **brc8x** Broadcast Remote Controller or by a **GPI/O** interface module. If the **C8685** receives such a number via the CAN bus, it will load the respective preset for example.

GPOs (Tallies)

may signal the status of a module. If you load a preset the C8685 puts the assigned number on the CAN bus so a C8817 **GPI/O** module may turn on a relay or the **brc8x** may turn on button LEDs (see respective manuals for details). The 8817 relays have **NO** (normally open) as well as **NC** (normally closed) contacts. This allows for easy interconnection with more generic monitoring equipment or very simple push button controls.